

Techtrol Displacer Type Magnetic Level Switch - DS

Available in six configurations to provide upto triple switchings for various industrial applications to operate pumps & auxiliary devices. Each configuration consists of displacers and switch carriages in various combinations.

Salient Features :

- ☑ Ease of handling & installation of large range switches
- ☑ Single, double or triple switchings, adjustable at site
- ☑ IP66 protection alongwith CE certification
- ☑ Ex-proof Gr. IIB or IIC enclosures for hazardous area
- ☑ Options:
 - High temperature design with radiating fins
 - Hermetically sealed switch casing
 - ATEX protection for enclosure alongwith CE certification.
 - NACE compliance
 - IBR approved switches available (separate datasheet)

Construction & Operation :

A single standard or two split displacers are suspended from a wire rope and connected to a coupler rod, carrying an actuator moving within a non-magnetic barrier tube via a compression spring (fig1). Initially when the displacer is not immersed in liquid, the spring is in compressed condition due to weight of the displacer so that the actuator is outside the magnetic field at position P1.

During rising level, the displacer gets immersed in liquid, undergoes weight loss (Archimedes Principle) causing an upward motion of the coupler rod, which makes the spring assume its original status and move the actuator to position P2 within the magnetic field, resulting in actuation of microswitches, to provide change over contacts. Narrow differential (nd) is achieved by using one standard displacer alongwith one switch carriage (fig2) and wide differential (wd) is achieved by using two split displacers alongwith one switch carriage (fig3) Narrow differential is fixed, however wide differential can be modified by varying the distance between split displacers.

Specifications :

Enclosure	: Cast Al, WP IP66 or Cast Al, Ex d Gr IIB or IIC T6, IP66 or Cast Al, ATEX Exd Gr IIB or IIC T6, IP66
Cable Entry	: 3/4"ET Gland (WP) or 1/2"NPT (F) or 1/2" NPT Gland (Exd) Brass
Measuring Range	: 200 to 15000 mm
Switch Carriage	: Microswitch or Microswitch in Hermetically Sealed Casing (Config. A,B,C,D & F only)
Switch Contacts	: DPDT (2 x SPDT) rated for 5A, 250VAC
Optg. Differential	: Refer Table-1 on page 3
Terminals	: Suitable for 1.5 mm ² cable conductor
Wire Rope	: SS304 or SS316, SS316L or PP or PTFE
Displacer	: Ø 60 x SS304/316/ 316L or PP or PVDF (config. E) or PTFE (config. A,B,C,D & F)
Displacer Type	: Standard or Split
Spring MOC	: SS316/316L, PTFE/ ECTFE ctd SS316
Process Flange	: CS, SS304/ SS316/ SS316L or PP or PTFE with steel cladding
Perforated Stillwell	: 65NB, CS or SS304/316/ 316L or PP
External Chamber	: 80NB, CS or SS304/316 or A-106
Temperature	: Standard -20 to 70°C (PP), 100°C (PVDF), 200°C (metallic) High Temp 300°C with Radiating Fins
Max Test Pressure	: Vacuum to 10 kg/cm ² (metallic), 2 kg/cm ² (PP/PTFE/PVDF) or High Pressure upto 100 kg/cm ² (metallic) Optional
Min SG	: 0.8 or Low SG upto 0.5 is available on demand



CE Ex IBR

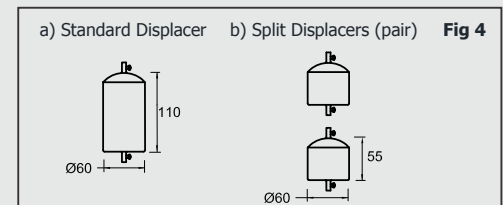
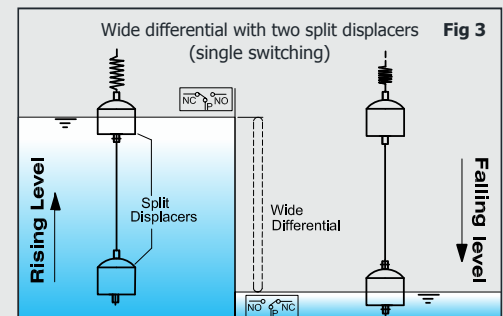
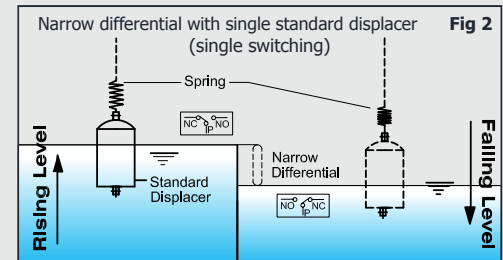
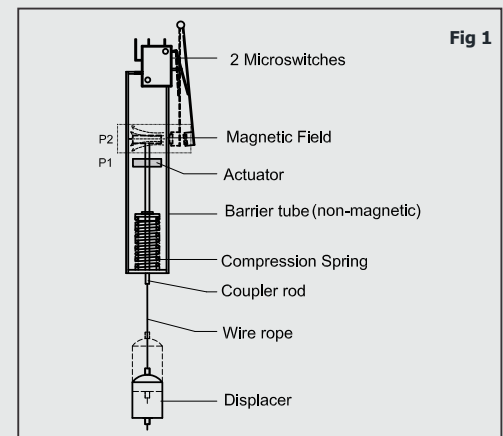

The working of six configurations are shown here under. The switching points L1, L2, L3 & L4 can be adjusted by relocating the displacers along the wire rope (range). Wide differential (wd) can be achieved and modified by varying the distance between the split displacers.

A) Single switching x one standard displacer with narrow diff.

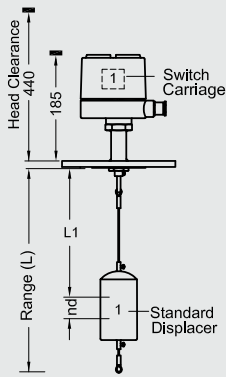

- ☑ L1 is adjustable
- ☑ Rising Level: Switch actuates at L1 & remains actuated during further level rise
- ☑ Falling Level: Switch de-actuates at (L1+nd) & remains de-actuated during further level fall
- ☑ Application: Point switching of one device i.e. Alarm or pump 'on or off' at L1 (SW1)

B) Single switching x two Split displacers with wide diff.

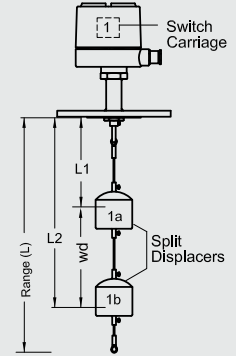

- ☑ L1 & L2 are adjustable
- ☑ Wide diff. can be modified
- ☑ Rising Level : Switch actuates at L1 & remains actuated during further level rise.
- ☑ Falling Level : Switch de-actuates at L2 & remains de-actuated during further level fall.
- ☑ Application : Control action of one device i.e. pump 'on-off' between L1& L2 (SW1)

Contact configurations:

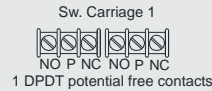

C) Dual switchings x two standard displacers with narrow diff.

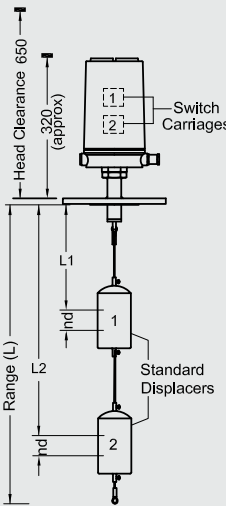

- ☑ L1 & L2 are adjustable
- ☑ Rising Level : Switch 2 actuates at L2 & switch 1 at L1 and both remain actuated during further level rise
- ☑ Falling Level : Switch 1 de-actuates at (L1+nd) & switch 2 at (L2+nd) and both remain de-actuated during further level fall
- ☑ Application : Point switching of two devices i.e. Alarm or Pump-1 'on or off' at L1 (SW1) & Alarm or Pump-2 'on or off' at L2 (SW2)

D) Dual switchings x one standard displacer with narrow diff. & two split displacers with wide diff.

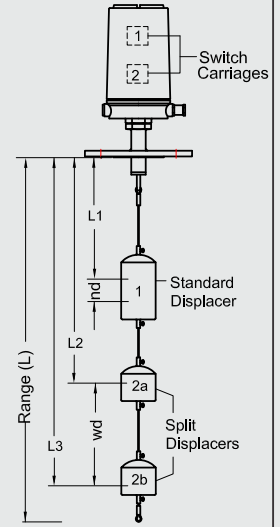

- ☑ L1, L2 & L3 are adjustable
- ☑ Wide diff. can be modified
- ☑ Rising Level : Switch 2 actuates at L2 & switch 1 at L1 and both remain actuated during further level rise
- ☑ Falling Level : Switch 1 de-actuates at (L1+nd) & switch 2 at L3 and both remain de-actuated during further level fall
- ☑ Application : Point switching & control action i.e. Alarm at L1 (SW1) and pump 'on-off' between L2 & L3 (SW2) or vice versa, by interchanging the position of standard & split displacers.

Contact configurations:

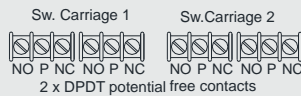

E) Triple switchings x three standard displacers with narrow diff.

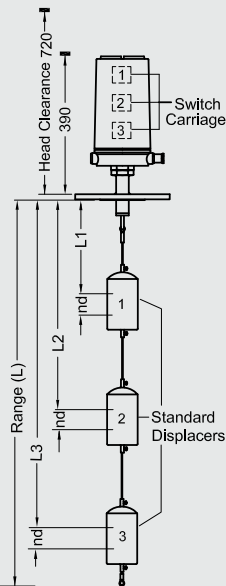

- ☑ L1, L2 & L3 are adjustable
- ☑ Rising Level : Switch 3 actuates L3, switch 2 at L2 & switch 1 at L1 and all remain actuated during further level rise
- ☑ Falling Level : Switch 1 actuates at (L1+nd), switch 2 at (L2+nd) & switch 3 at (L3+nd) and all remain de-actuated during further level fall
- ☑ Application : Point switching of three devices

F) Dual switchings x four split displacers with wide diff.

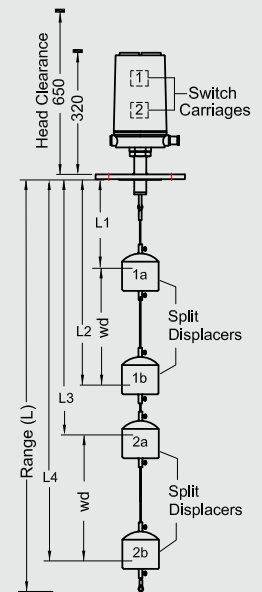

- ☑ L1, L2, L3 & L4 are adjustable
- ☑ Wide diff. can be modified
- ☑ Rising Level : Switch 2 actuates at L3 & switch 1 at L1 & both remain actuated during further level rise
- ☑ Falling Level : Switch 1 de-actuates at L2 & switch 2 at L4 and both remain de-actuated during further level fall
- ☑ Applications : Control action of two devices i.e. Pump 1 'on-off' between L1 & L2 (SW1) & pump 2 'on-off' between L3 & L4 (SW2)

Contact configurations:

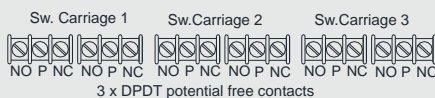

Contact configurations:

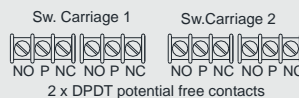

Table 1 - Operating differentials for six configurations

Config.	Switch Carriages	Displacers	*Differential (sp.gr.1)
A	One	Standard	Narrow (40±5mm)
B	One	Split	Wide
C	Two	Two Standard	Narrow (40±5mm)
D	Two	One Standard + Two Split	Narrow (40±5mm) Wide
E	Three	Three Standard	Narrow (65±5mm)
F	Two	Four Split	Wide

* Differential is inversely proportional to sp. gr.of liquid

Installation :

The switch can be installed internally on tank (fig 5a) or internally with stillwell for tanks having turbulence (fig 5b) or externally in a chamber to overcome limited space within the tank or where mechanical devices like stirrers operate (fig 5c)

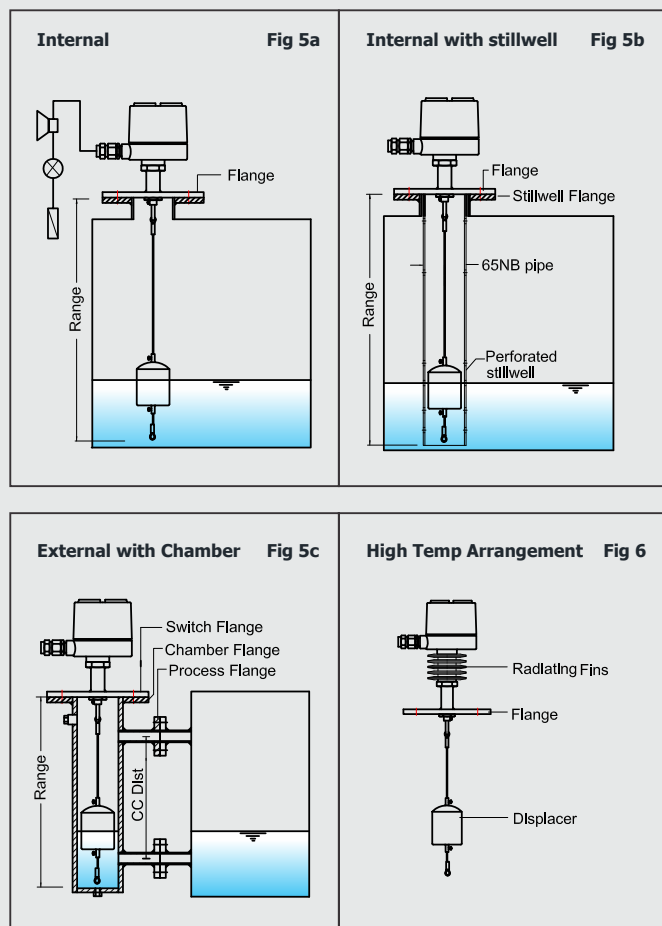

Applications :

Large Sumps & Fuel Tanks, Oil Sumps, Boiler Feed Water, Acid / Alkali Dosing Tanks in Waste Water / Sewage / Effluent Treatment.

Ordering Information :

Model no x Range (mm) x Liquid & its Sp.gr x Operating Temperature and Pressure.

* All dimensions in mm except specified

Pune Techtrol Pvt Ltd [CIN : U31909PN1991PTC063403]

S-18, MIDC, Bhosari, Pune - 411026. India

+91-20-66342900 | ho@punetechtrol.com | www.punetechtrol.com

Works : J-52/7, MIDC, Bhosari, Pune - 411026. India | +91-20-67313600

Custom built specs./options available on demand.

We reserve the right to modify design and specifications without prior notice.

Model Identification

		DS -							
1. Configuration (Magnetic Switch Carriage x Displacer)									
One x One (Standard)		A							
One x Two (Split)		B							
Two x Two (Standard)		C							
Two x Three (Standard + Split)		D							
Three x Three (Standard)		E							
Two x Four (Split)		F							
2. Enclosure x Cable Entry									
Cast Al IP66 x ¾" ET Gland		J							
Cast Al IP66 x ½" NPT Double Comp'n Gland		K							
Cast Al IP66 x ½" NPT (F)		L							
Cast Al Ex d Gr IIB x ½" NPT Double Comp'n Gland		E							
Cast Al Ex d Gr IIC x ½" NPT Double Comp'n Gland (Config. A,B,C, D & F)		F							
Cast Al ATEX Ex d Gr IIB x ½" NPT Double Comp'n Gland		G							
Cast Al ATEX Ex d Gr IIC x ½" NPT Double Comp'n Gland (Config. A,B,C, D & F)		H							
Cast Al Ex d Gr IIB x ½" NPT (F)		M							
Cast Al Ex d Gr IIC x ½" NPT (F)		N							
Cast Al ATEX Ex d Gr IIB x ½" NPT (F) (Config. A,B,C, D & F)		Q							
Cast Al ATEX Ex d Gr IIC x ½" NPT (F) (Config. A,B,C, D & F)		R							
Cast Al IP66 x Plug & Socket		T							
Others		O							
3. Displacer MOC									
SS304					N				
SS316					S				
SS316L					L				
PP					P				
PVDF (Config. E)					F				
PTFE (Config. A, B, C, D & F)					T				
Others					O				
4. Process Connection MOC									
CS						M			
SS304						N			
SS316						S			
SS316L						L			
PP with steel cladding						P			
PTFE with steel cladding						T			
Others						O			
5. Process Connection Size & Type									
80 NB ASME 150 # Flange							1		

80 NB ASME 300 # Flange		2				
80 NB ASME 600 # Flange		3				
Others		O				
6. Magnetic Switch Carriage						
Micro Switch (2 x SPDT)			M			
Micro Switch in Hermetically Sealed Casing (2 x SPDT), (A,B,C,D & F Config only)			H			
Others			O			
7. Temperature						
Standard - 70°C (PP), 100 °C (PVDF/PTFE) , 200 °C (Metallic)				S		
High Temp - 300 °C with Radiating Fins				H		
8. Special Features						
Without					W	
Low SG Displacer					L	
Others					O	
9. Accessories						
Without						W
CS Stillwell						M
SS304 Stillwell						N
SS316 Stillwell						S
SS316L Stillwell						L
PP Stillwell						P
External Chamber (Refer ECT catalog)						C
Others						O

Ordering Information

Model No x Measuring Range x Liquid & its SG x Operating Temperature & Pressure